

A150 Clip

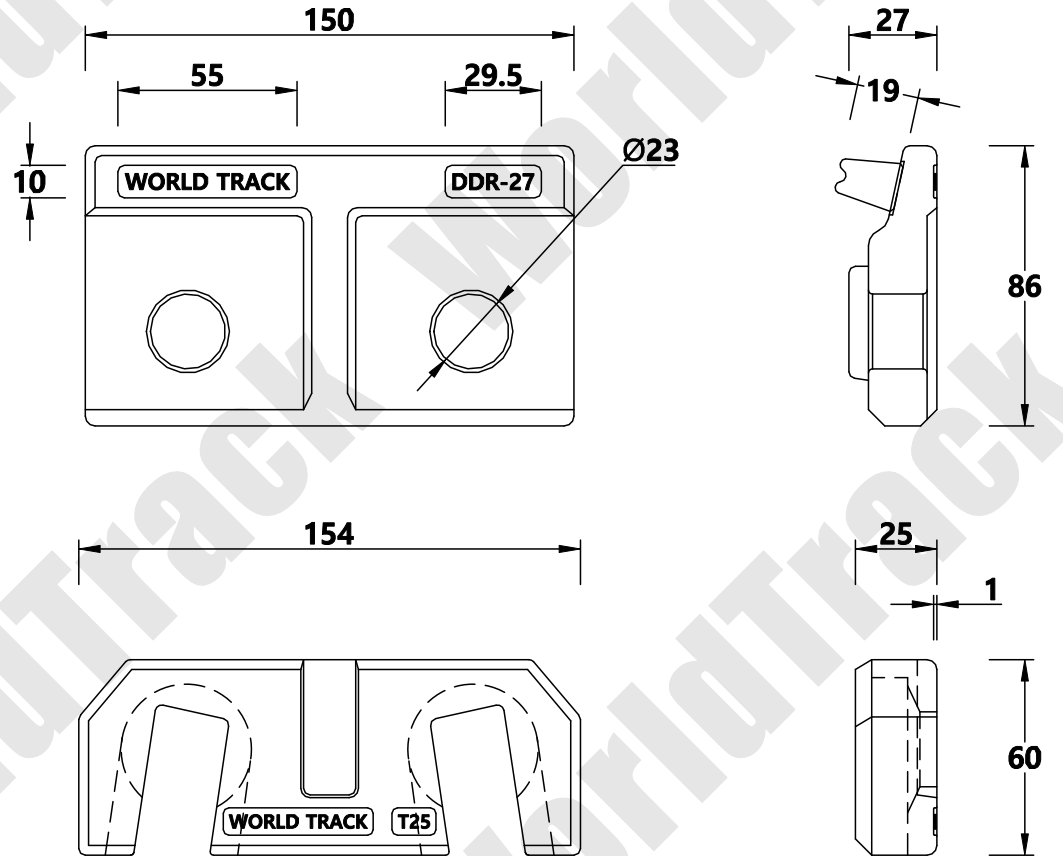
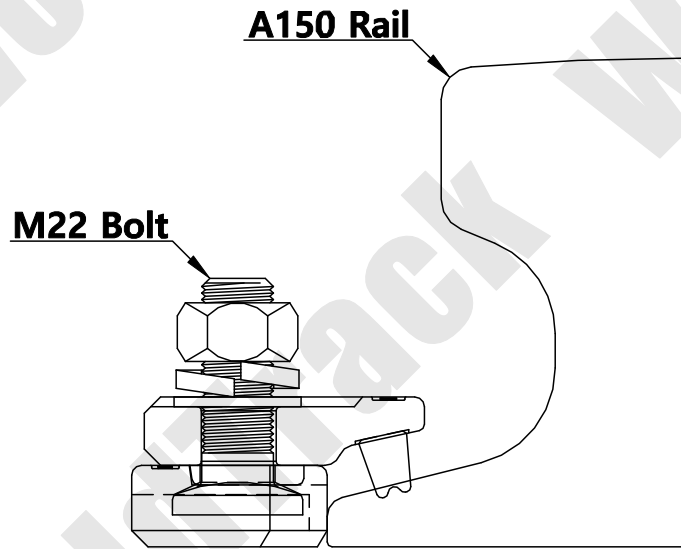

WORLD TRACK

THE TECHNICAL DATA CONTAINED IN THIS DRAWING IS PROPERTY OF WORLD TRACK LIMITED AND IS SUBJECT TO COPYRIGHT

WORLD TRACK

TEL : 82)2-2605-2380
 FAX : 82)2-2601-2382
<http://www.world-track.net>
 E-Mail: world-track@hanmail.net

Clip Designation	150/DDR-PN-T1/2725	Drawing Number	C/DDR-215
Clip Type	Double Double Rubber	Checked By	Lee Se Wan
Fixing Method	Bolted Clip	Date	2016 / 02 / 29
Accessory List	Clip(상), Clip(하) / Rubber Bolt / Nut / Spring Washer / Washer	Scale	1 / 1 A4
		ANGLE PROJECTION	