

A75 Clip

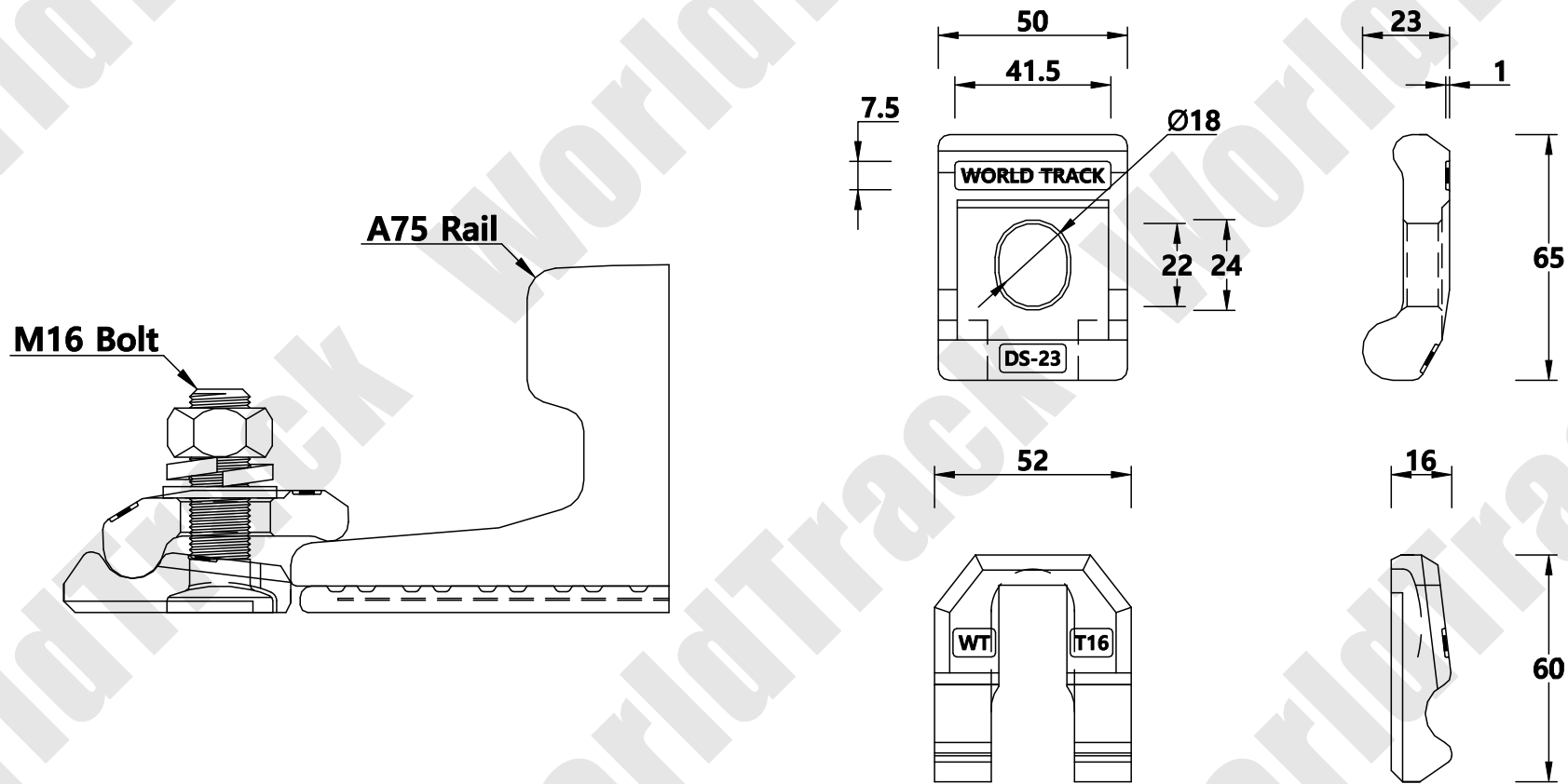

WORLD TRACK

THE TECHNICAL DATA CONTAINED IN THIS DRAWING IS PROPERTY OF WORLD TRACK LIMITED AND IS SUBJECT TO COPYRIGHT

WORLD TRACK

TEL : 82)2-2605-2380
 FAX : 82)2-2601-2382
<http://www.world-track.net>
 E-Mail: world-track@hanmail.net

Clip Designation	75/DS-PY-T2/2316	Drawing Number	C/DS-250	
Clip Type	Double Single	Checked By	Lee Se Wan	
Fixing Method	Bolted Clip	Date	2016 / 01 / 21	
Accessory List		Scale	1 / 1	A4
Clip(상), Clip(하) Bolt / Nut / Spring Washer / Washer		ANGLE PROJECTION		