

A150 Clip

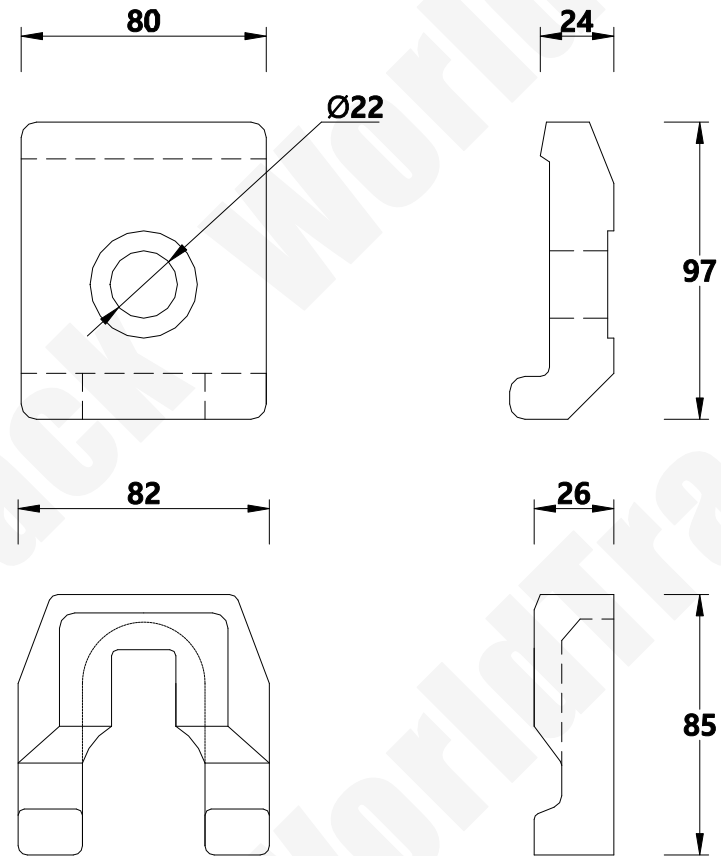
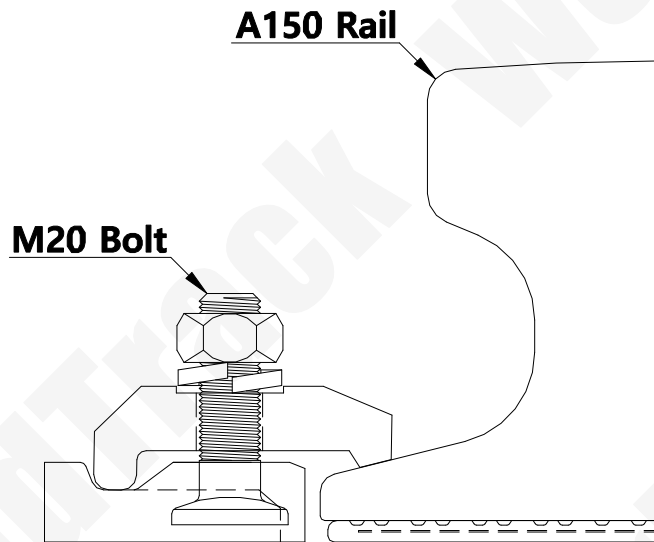

WORLD TRACK

THE TECHNICAL DATA CONTAINED IN THIS DRAWING IS PROPERTY OF WORLD TRACK LIMITED AND IS SUBJECT TO COPYRIGHT

WORLD TRACK

TEL : 82)2-2605-2380
 FAX : 82)2-2601-2382
<http://www.world-track.net>
 E-Mail: world-track@hanmail.net

Clip Designation

150/DS-PY-T1/2426

Drawing Number

C/DS-360

Clip Type

Double Single

Checked By

Lee Se Wan

Fixing Method

Bolted Clip

Date

2016 / 01 / 21

Accessory List

Clip(상), Clip(하)

Bolt / Nut / Spring Washer / Washer

Scale

1 / 1 A4

ANGLE PROJECTION

