

A75 Clip

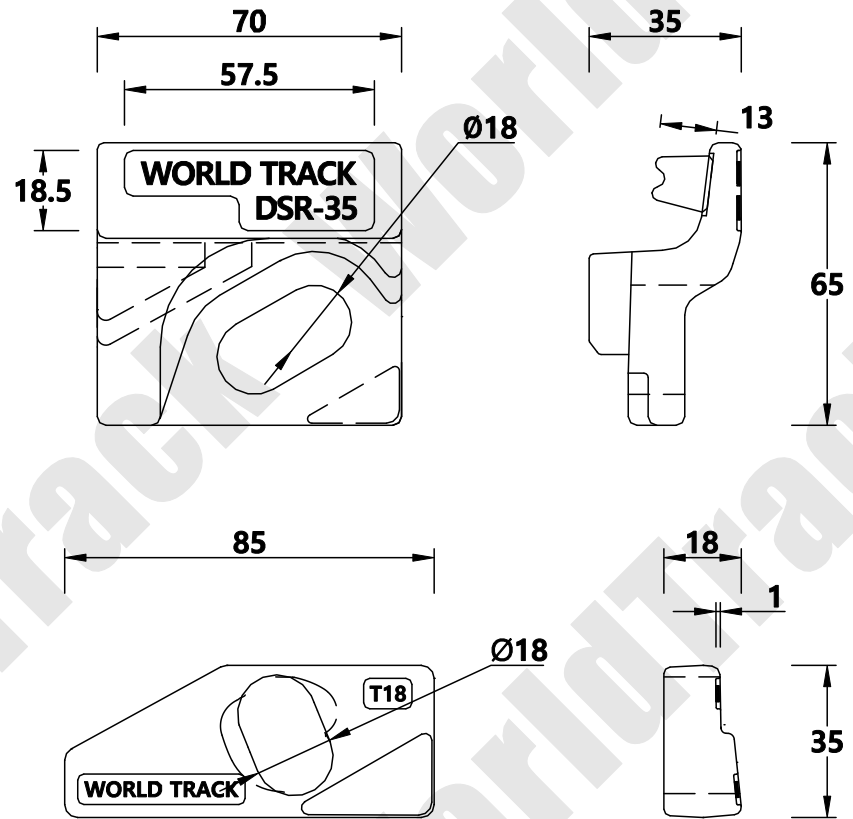
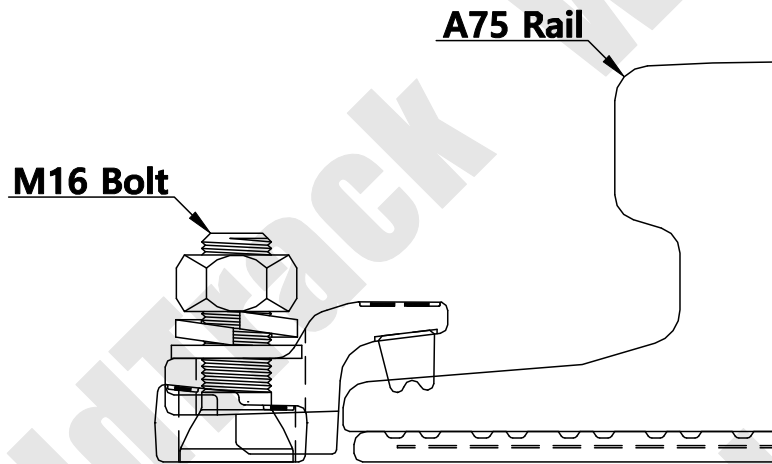

WORLD TRACK

THE TECHNICAL DATA CONTAINED IN THIS DRAWING IS PROPERTY OF WORLD TRACK LIMITED AND IS SUBJECT TO COPYRIGHT

WORLD TRACK

TEL : 82)2-2605-2380
 FAX : 82)2-2601-2382
<http://www.world-track.net>
 E-Mail: world-track@hanmail.net

Clip Designation	75/DSR-PY-T2/3518
Clip Type	Double Single Rubber
Fixing Method	Bolted Clip
Accessory List	
Clip(상), Clip(하) / Rubber	
Bolt / Nut / Spring Washer / Washer	

Drawing Number	C/DSR-105
Checked By	Lee Se Wan
Date	2016 / 01 / 25
Scale	1 / 1 A4

ANGLE PROJECTION