

# A150 Clip

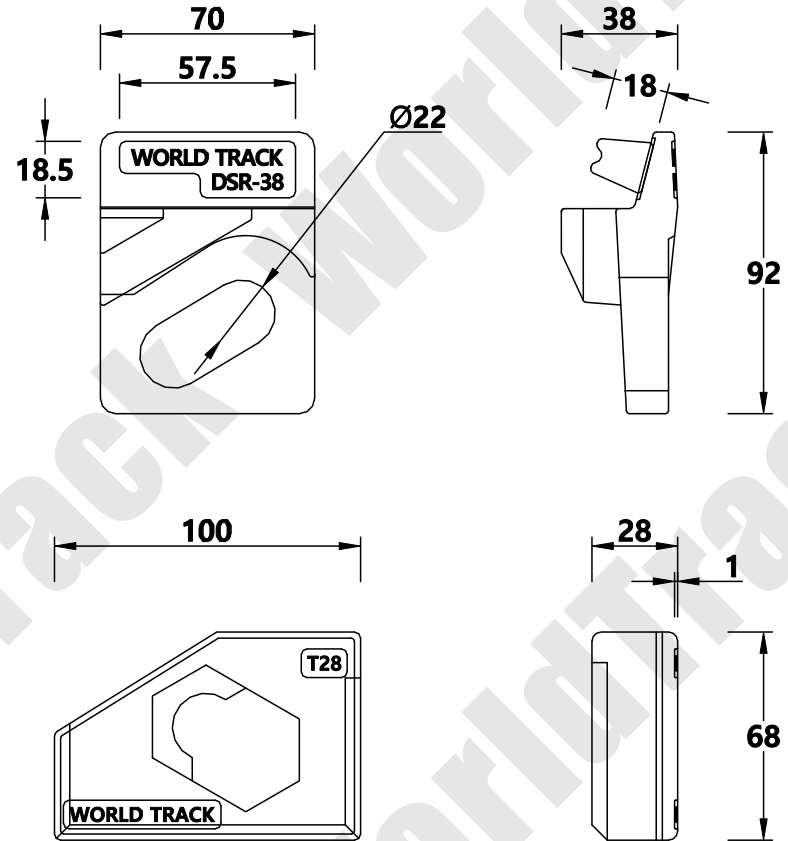
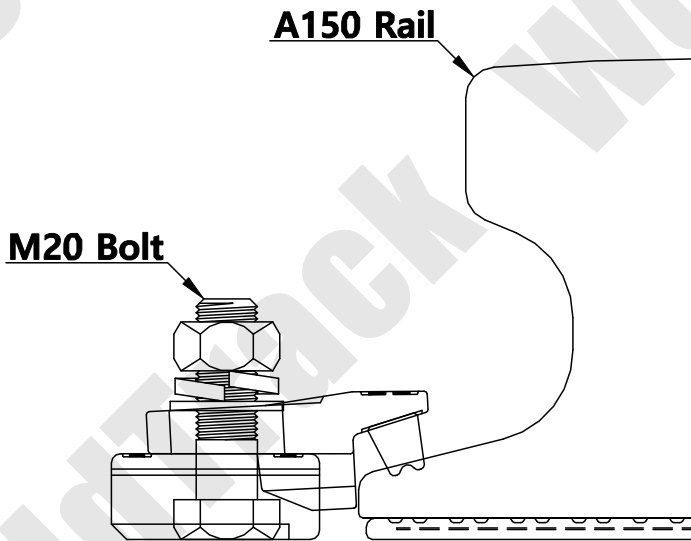

**WORLD TRACK**

THE TECHNICAL DATA CONTAINED IN THIS DRAWING IS PROPERTY OF WORLD TRACK LIMITED AND IS SUBJECT TO COPYRIGHT

**WORLD TRACK**

TEL : 82)2-2605-2380  
 FAX : 82)2-2601-2382  
<http://www.world-track.net>  
 E-Mail: world-track@hanmail.net

Clip Designation	150/DSR-PY-T1/3828	Drawing Number	C/DSR-200
Clip Type	Double Single Rubber	Checked By	Lee Se Wan
Fixing Method	Bolted Clip	Date	2016 / 01 / 25
Accessory List		Scale	1 / 1 A4
Clip(상), Clip(하) / Rubber		<b>ANGLE PROJECTION</b>	
Bolt / Nut / Spring Washer / Washer			