

A120 Clip

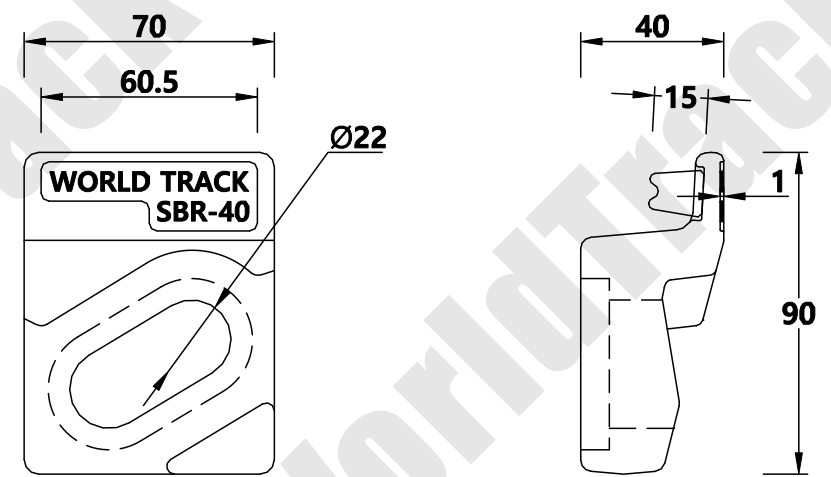
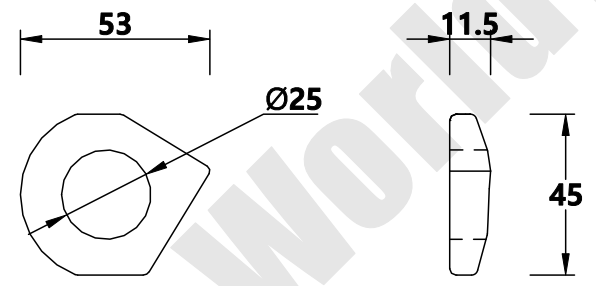
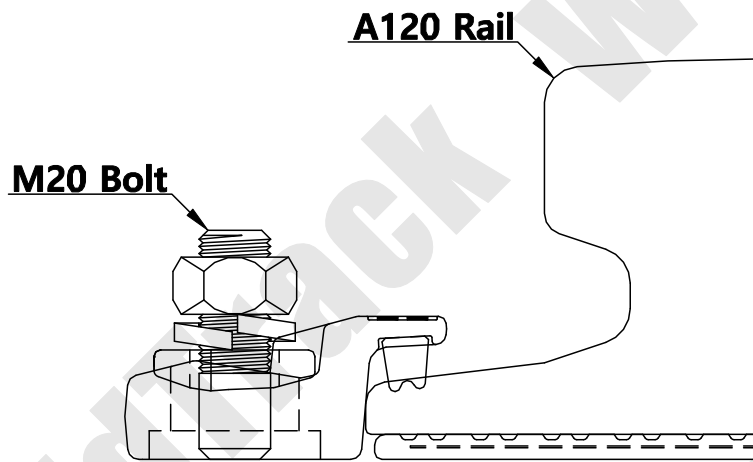

WORLD TRACK

WORLD TRACK

TEL : 82)2-2605-2380
 FAX : 82)2-2601-2382
<http://www.world-track.net>
 E-Mail: world-track@hanmail.net

Clip Designation	120/SBR-PY-T1/40	Drawing Number	C/SBR-070
Clip Type	Single Bolt Rubber	Checked By	Lee Se Wan
Fixing Method	Bolted Clip	Date	2016 / 03 / 07
Accessory List		Scale	1 / 1 A4
Clip / Rubber		ANGLE PROJECTION	
Bolt / Nut / Special Washer / Spring Washer			

THE TECHNICAL DATA CONTAINED IN THIS DRAWING IS PROPERTY OF WORLD TRACK LIMITED AND IS SUBJECT TO COPYRIGHT